

CWDM Add Drop модуль, LC, 1610nm

Пассивный оптический модуль позволяет оперировать каналом на длине волны 1610nm в двухволоконной CWDM системе.

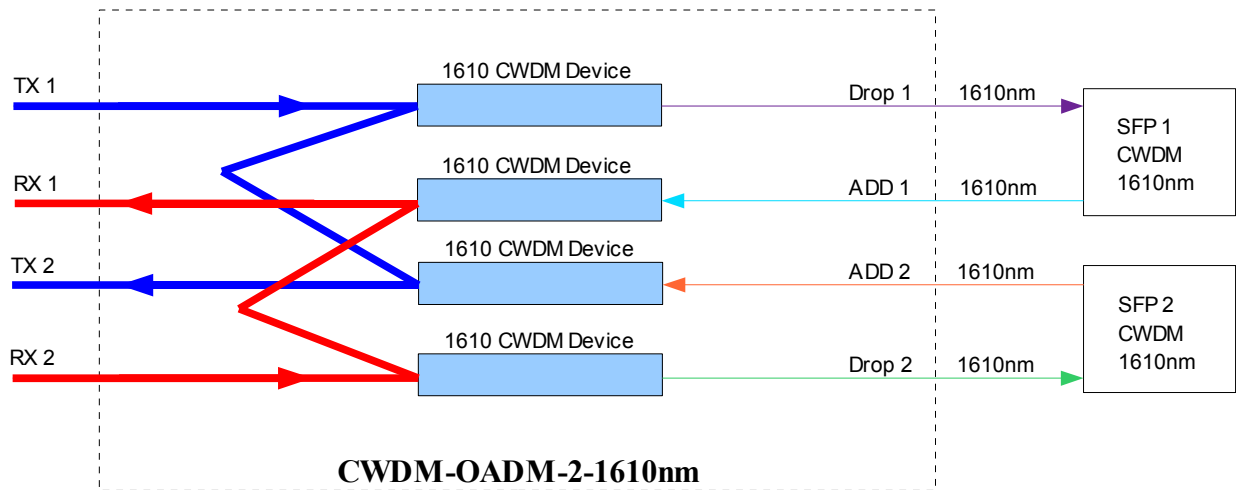
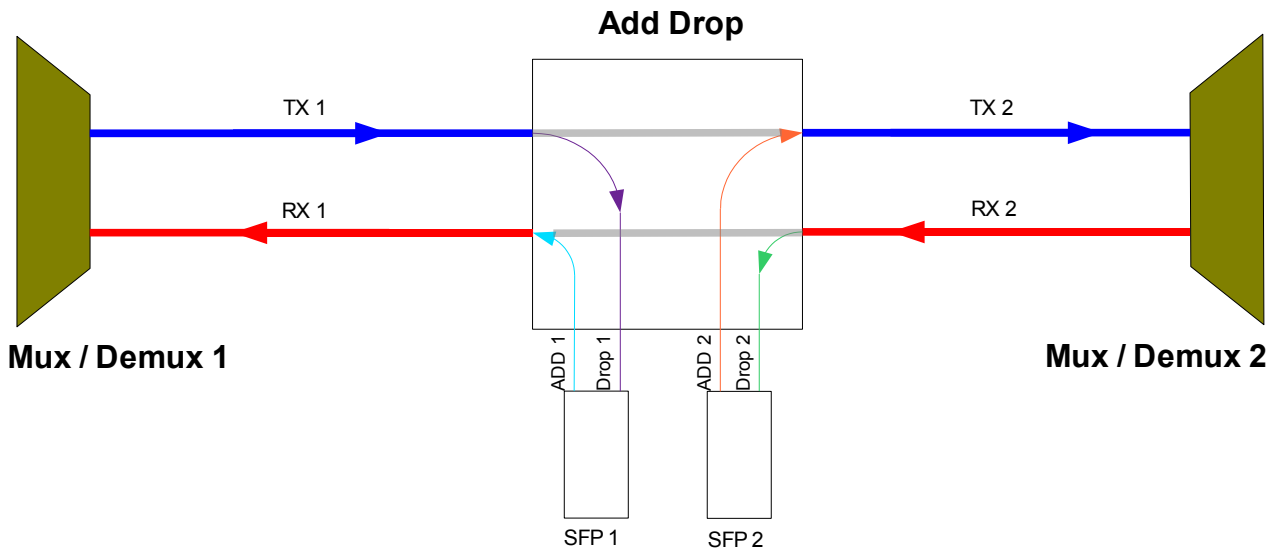

Технические характеристики:

Parameter	
Express Channel	1310, 1330, 1350, 1370, 1390, 1410, 1430, 1450, 1470, 1490, 1510, 1530, 1550, 1570, 1590

Add Drop Channel	1610nm
IL @Express Channel TX1 to TX2	≤0.7 dB
IL @Express Channel RX2 to RX1	≤0.7 dB
Express Channel Isolation	≥ 22
IL @ Drop 1	≤0.8 dB
IL @ Drop 2	≤0.8 dB
IL @ ADD 1	≤0.8 dB
IL @ ADD 2	≤0.8 dB
Add Drop Channel Isolation	≥ 30
Optical Power Handling	≥ 300mW
Operating Temperature	0 to +70°C
Storage Temperature	-30 to +85°C
Connector Type	4 pcs LC/UPC duplex
Packaging Dimension	19" 1U-height Patch panel type