

CWDM-BiDi Add Drop модуль, LC, 1390-1550nm

Пассивный оптический модуль позволяет оперировать каналом на длинах волн 1390, 1550nm, образующих двунаправленный канал в одноволоконной CWDM системе.

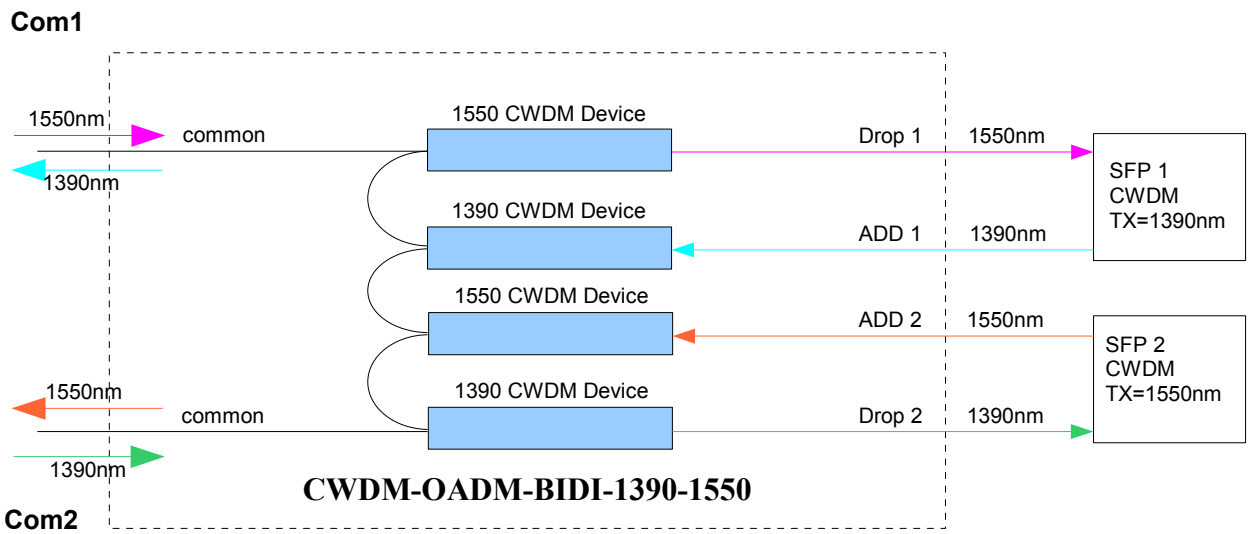
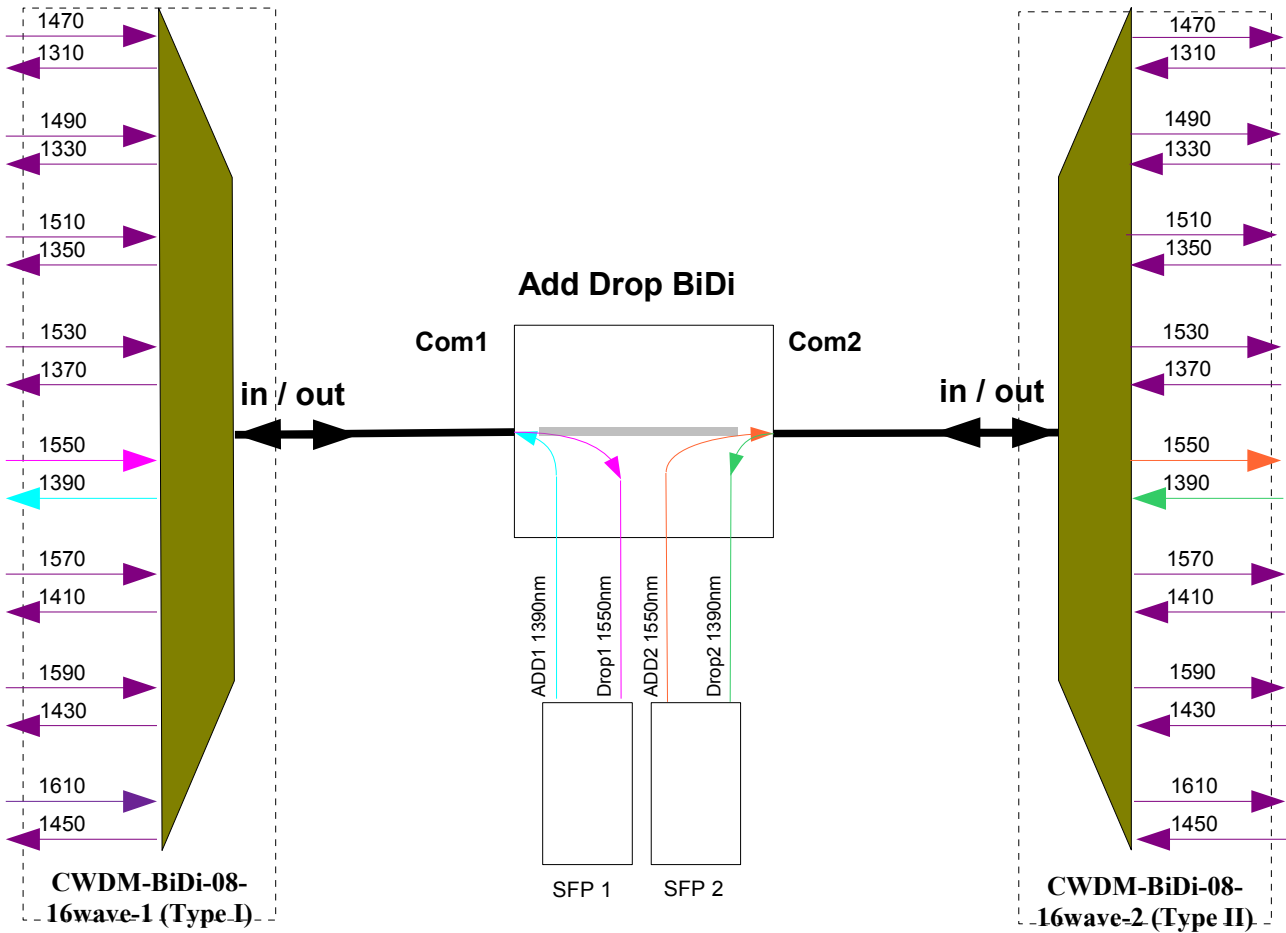

Технические характеристики:

Parameter	
Express Channel	1310, 1330, 1350, 1370, 1410, 1430, 1450, 1470, 1490, 1510, 1530, 1570, 1590, 1610
Add Drop Channel	1390, 1550nm
Bandwidth @ -0.5dB	≥ 15nm
Add-Drop Channel Ripple	≤ 0.3 dB
IL @Express Channel	≤ 1.4 dB
Express Channel Isolation	≥ 22
IL @ Drop 1	≤0.8 dB
IL @ ADD 1	≤1.2 dB
IL @ Drop 2	≤1.2 dB
IL @ ADD 2	≤0.8 dB
Polarization Dependent Loss	≤0.1 dB
Add Drop Channel Isolation(Adjacent)	≥ 30 dB
Add Drop Channel Isolation(No-Adjacent)	≥ 40 dB
Return Loss	≥ 45 dB
Directivity	≥ 55 dB
Optical Power Handling	≥ 500mW
Operating Temperature	0 to +70°C
Storage Temperature	-30 to +85°C
Connector Type	6 pcs LC/UPC
Packaging Dimension	19" 1U-height Patch panel type