

Свойства

передача данных по одному волокну

1270нм DFB лазер

1270 / 1330нм WDM фильтр

до 20км на 9/125 мкм одномодовом оптическом кабеле

цифровая диагностика (DDMI)

LC коннектор

Применение

10GBase-LR

STM-64/16

10G FC

● **Максимальные параметры**

Parameter	Symbol	Min.	Typical	Max.	Unit
Storage Temperature	T _S	-40		+85	°C
Case Operating Temperature	T _A	-5		+70	°C
Maximum Supply Voltage	V _{CC}	-0.5		4	V
Relative Humidity	RH	0		85	%

● **Рекомендованные параметры**

Parameter	Symbol	Min.	Typical	Max.	Unit
Case operating Temperature	T _C	-5		+70	°C
Supply Voltage	V _{CC,T,R}	+3.135		+3.465	V

Supply Current	I_{CC}			350	mA
Power Dissipation	P_D			1.5	W

● **Электрические характеристики**

◇ Parameter		Symbol	Min	Typ	Max	Unit	Note
Transmitter:							
Differential input voltage swing			180		700	mVpp	1
Transmit Disable Input	H	V_{IH}	2.0		$V_{CC}+0.3$	V	
	L	V_{IL}	0		0.8	V	
Transmit Enable Output	H	V_{OH}	2.4		$V_{CC}+0.3$	V	
	L	V_{OL}	0		0.4	V	2
Input Differential Impedance		Z_{in}	80	100	120	Ω	
Receiver							
Differential output voltage swing			300		850	mVpp	3
LOS Output	H	V_{OH}	2.4		$V_{CC}+0.3$	V	2
	L	V_{OL}	0		0.4	V	
Output Differential Impedance		Z_{on}	80	100	120	Ω	

Notes:

Note 1) TD+/- are internally AC coupled with 100 Ω differential termination inside the module.

Note 2) Tx Fault and Rx LOS are open collector outputs, which should be pulled up with 4.7k to 10k Ω resistors on the host board. Pull up voltage between 2.0V and $V_{CC}+0.3V$.

Note 3) RD+/- outputs are internally AC coupled, and should be terminated with 100 Ω (differential) at the user SERDES.

● Оптические параметры

Parameter	Symbol	Min	Typ	Max	Unit	Ref.
Transmitter						
Bit Rate	BR	9.9		11.3	Gb/s	
Optical Wavelength	λ	1260	1270	1280	nm	
Average output power	P _o	-1		+3	dBm	
Optical Extinction Ratio	ER	3.5			dB	
Spectral width	$\Delta\lambda$			1	nm	
Side Mode Suppression Ratio	SMSR	30			dB	
Optical Eye Mask		Compliant with IEEE802.3ae				
Receiver						
Bit Rate	BR	9.9		11.3	Gb/s	
Optical Wavelength	λ	1320	1330	1340	nm	
Receiver Sensitivity	Sen			-15	dBm	1
Maximum Input Power	P _{MAX}	0			dBm	
LOS De-Assert	LOS _D			-15.5	dBm	
LOS Assert	LOS _A	-25			dBm	
LOS Hysteresis	LOS _H	0.5		4	dB	

Notes:

Note 1) Measured with a PRBS of 2³¹-1 at 1 x 10⁻¹² BER and 3.5 dB extinction ratio.

● Контакты разъема SFP slot

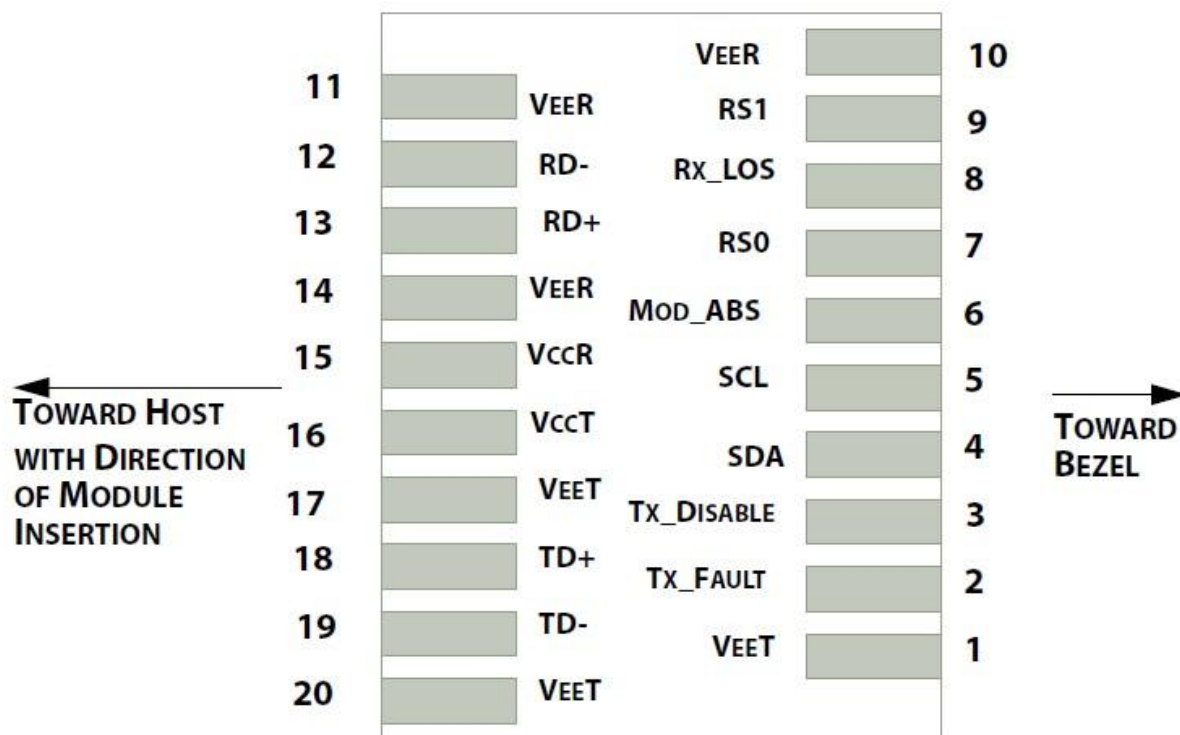

● Описание контактов

PIN #	Name	Function	Notes
1	VeeT	Module transmitter ground	1
2	Tx Fault	Module transmitter fault	2
3	Tx Disable	Transmitter Disable; Turns off transmitter laser output	3
4	SDL	2 wire serial interface data input/output (SDA)	
5	SCL	2 wire serial interface clock input (SCL)	
6	MOD-ABS	Module Absent, connect to VeeR or VeeT in the module	2
7	RS0	Rate select0, optionally control SFP+ receiver. When high, input data rate >4.5Gb/ s; when low, input data rate <=4.5Gb/s	
8	LOS	Receiver Loss of Signal Indication	4
9	RS1	Rate select0, optionally control SFP+ transmitter. When	

		high, input data rate >4.5Gb/s; when low, input data rate <=4.5Gb/s	
10	VeeR	Module receiver ground	1
11	VeeR	Module receiver ground	1
12	RD-	Receiver inverted data out put	
13	RD+	Receiver non-inverted data out put	
14	VeeR	Module receiver ground	1
15	VccR	Module receiver 3.3V supply	
16	VccT	Module transmitter 3.3V supply	
17	VeeT	Module transmitter ground	1
18	TD+	Transmitter inverted data out put	
19	TD-	Transmitter non-inverted data out put	
20	VeeT	Module transmitter ground	1

Note:

1. The module ground pins shall be isolated from the module case.
2. This pin is an open collector/drain output pin and shall be pulled up with 4.7K-10Kohms to Host_Vcc on the host board.
3. This pin shall be pulled up with 4.7K-10Kohms to VccT in the module.
This pin is an open collector/drain output pin and shall be pulled up with 4.7K-10Kohms to Host_Vcc on the host board.

● **EEPROM и DDMI**

The SFP modules implement the 2-wire serial communication protocol as defined in the SFP - 8472. The serial ID information of the SFP modules and Digital Diagnostic Monitor parameters can be accessed through the I²C interface at address A0h and A2h. The memory is mapped in Table 1. Detailed ID information (A0h) is listed in Table 2. And the DDM specification at address A2h. For more details of the memory map and byte definitions, please refer to the SFF-8472, “Digital Diagnostic Monitoring Interface for Optical Transceivers”. The DDM parameters have been internally calibrated.

Table 1. Digital Diagnostic Memory Map (Specific Data Field Descriptions)

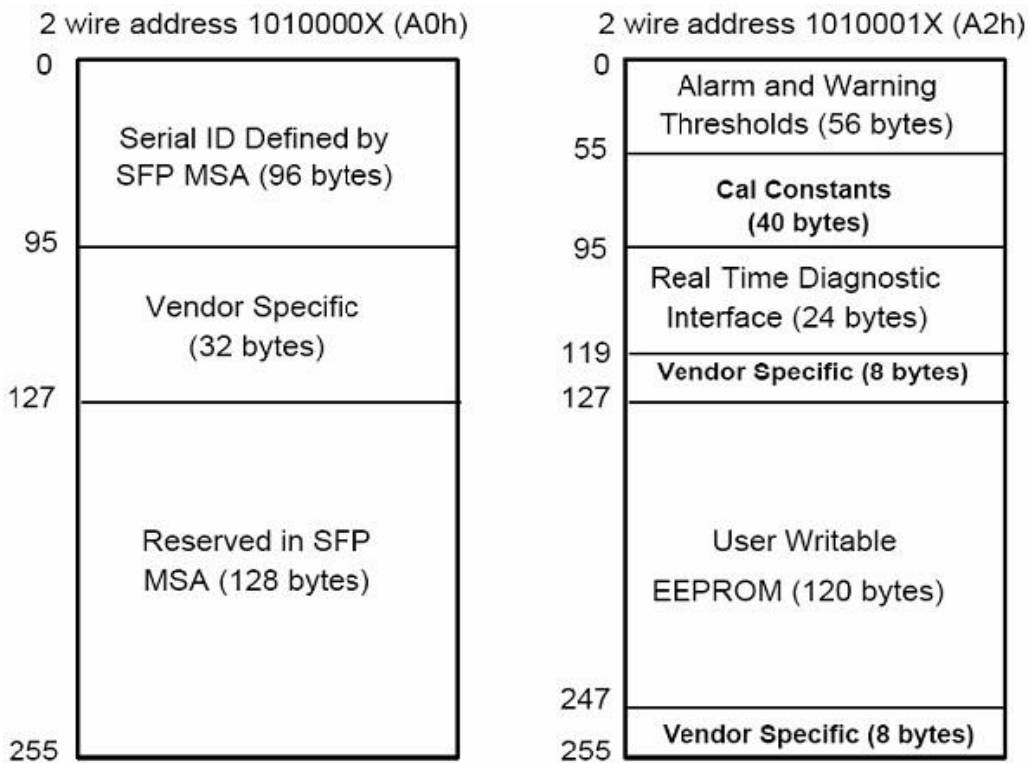

Table 2 - EEPROM Serial ID Memory Contents (A0h)

Data Address	Length (Byte)	Name of Length	Description and Contents
Base ID Fields			
0	1	Identifier	Type of Serial transceiver (03h=SFP)
1	1	Reserved	Extended identifier of type serial transceiver (04h)
2	1	Connector	Code of optical connector type (07=LC)
3-10	8	Transceiver	10G Base-LR
11	1	Encoding	64B/66B
12	1	BR, Nominal	Nominal baud rate

13-14	2	Reserved	(0000h)
15	1	Length(9um)	Link length supported for 9/125um fiber, units of 100m
16	1	Length(50um)	Link length supported for 50/125um fiber, units of 10m
17	1	Length(62.5um)	Link length supported for 62.5/125um fiber, units of 10m
18	1	Length(Copper)	Link length supported for copper, units of meters
19	1	Reserved	
20-35	16	Vendor Name	SFP vendor name: OptTech
36	1	Reserved	
37-39	3	Vendor OUI	SFP transceiver vendor OUI ID
40-55	16	Vendor PN	Part Number (ASCII)
56-59	4	Vendor rev	Revision level for part number
60-62	3	Reserved	
63	1	CCID	Least significant byte of sum of data in address 0-62
Extended ID Fields			
64-65	2	Option	Indicates which optical SFP signals are implemented (001Ah = LOS, TX_FAULT, TX_DISABLE all supported)
66	1	BR, max	Upper bit rate margin, units of %
67	1	BR, min	Lower bit rate margin, units of %
68-83	16	Vendor SN	Serial number (ASCII)
84-91	8	Date code	OptTech Manufacturing date code
92-94	3	Reserved	
95	1	CCEX	Check code for the extended ID Fields (addresses 64 to

			94)
Vendor Specific ID Fields			
96-127	32	Readable	OptTech specific date, read only
128-255	128	Reserved	Reserved for SFF-8079

● **Digital Diagnostic Monitor Characteristics**

Data Address	Parameter	Accuracy	Unit
96-97	Transceiver Internal Temperature	±3.0	°C
98-99	VCC3 Internal Supply Voltage	±3.0	%
100-101	Laser Bias Current	±10	%
102-103	Tx Output Power	±3.0	dBm
104-105	Rx Input Power	±3.0	dBm

● **Рекомендованная схема включения**

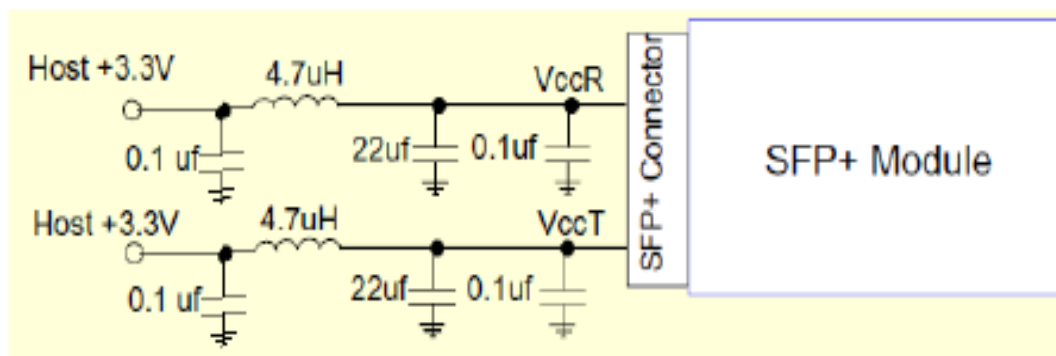

Recommended Host Board Power Supply Circuit

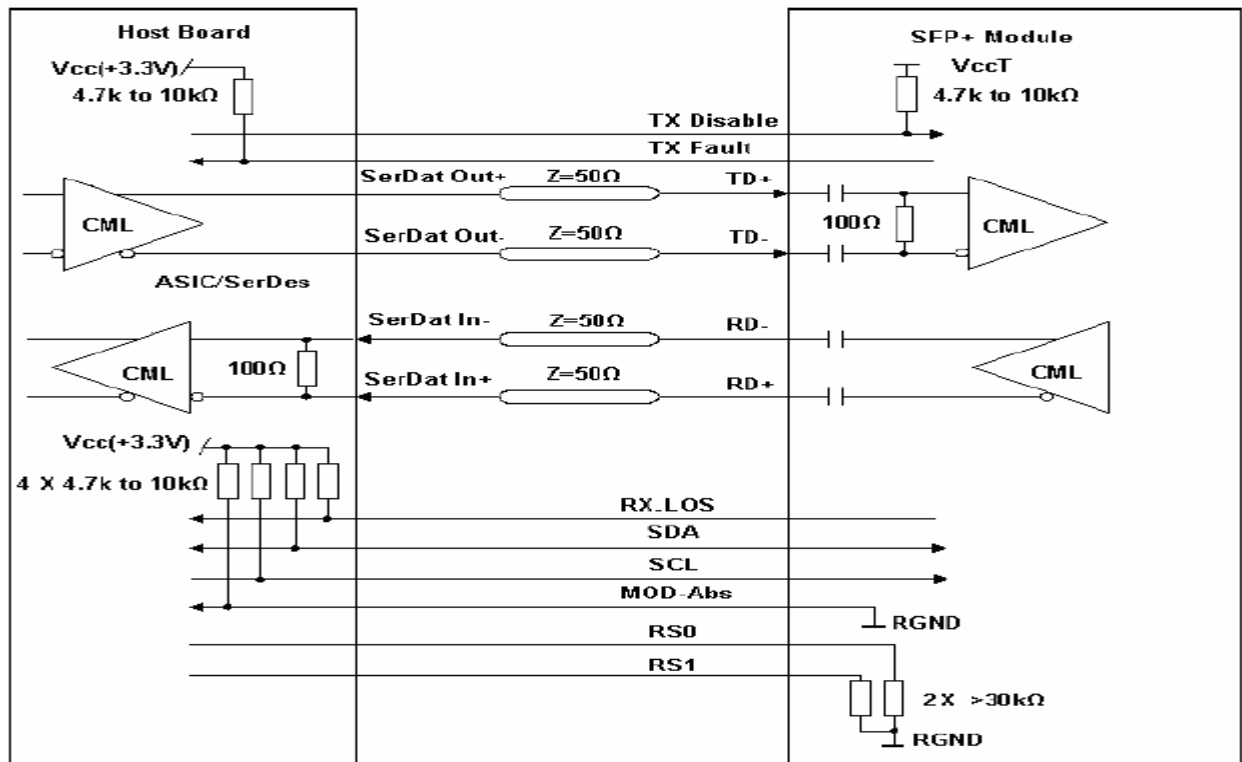

Recommended High-speed Interface Circuit

● Размеры

